

Fusible Plugs

FPP, FPT Series

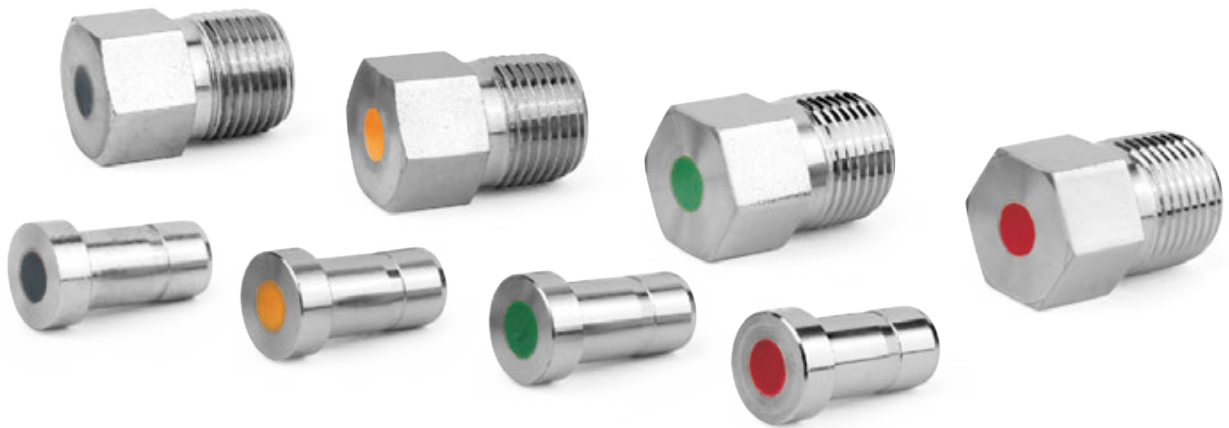

FITOK

www.fitokgroup.com

1 Fusible Plugs

Application

Fusible plugs are pressure relief devices consisting of the body and the eutectic alloy. The eutectic alloy has a specific melting point. When the plug is exposed to temperatures at or above this melting point, the eutectic alloy will melt and the pressure inside the plug will be released to the atmosphere for protection of systems.

Features

- ⦿ Eutectic alloy is filled in the stainless steel plug
- ⦿ For liquid or gas service
- ⦿ Fusible plugs are non-reusable and disassembled pressure relief devices
- ⦿ Maximum operating pressure: Tested to 500 psig (3.4 MPa)
- ⦿ Temperature rating from 160°F (71°C) to 281°F (138°C) with 4 temperature ranges
- ⦿ Two types of end connections : Pipe threads and tube adapters

Construction

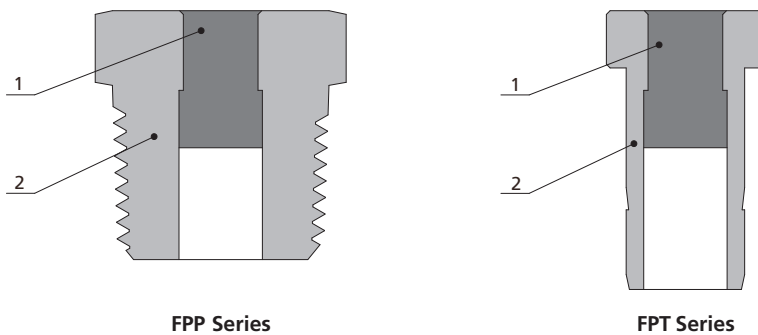

Item	Component	Material
1	Eutectic alloy	
2	Body	Stainless steel

Fusible Alloy Option with Different Melting Point

Melting Point °F (°C)		Designator	Color Code	Stamp
°F	°C			
160	71	160	Black	160
212	100	212	Orange	212
255	124	255	Green	255
281	138	281	Red	281

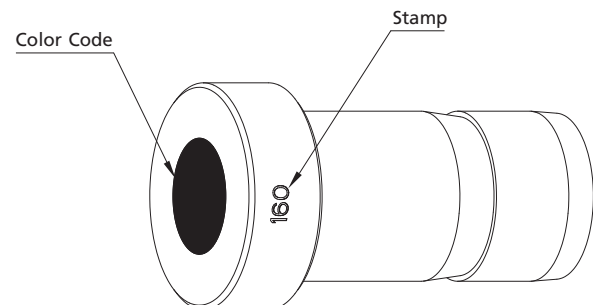

Dimensions

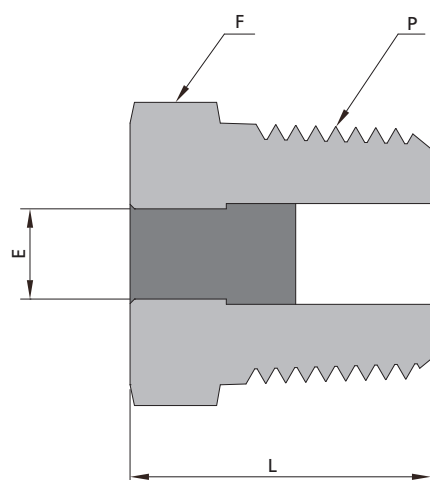

FPP Series

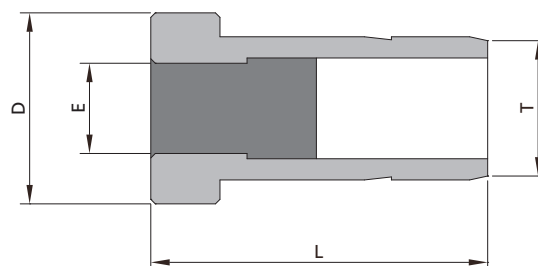

FPT Series

FPP Series

Basic Ordering No.	Pipe Size (P)	Dimensions, in. (mm)		
		L	E	F (Hex.)
□□-FPP-4-□□□	1/4 NPT	0.95 (24.1)	0.25 (6.4)	9/16 (14.29)
□□-FPP-6-□□□	3/8 NPT	1.06 (26.9)	0.25 (6.4)	11/16 (17.46)
□□-FPP-8-□□□	1/2 NPT	1.20 (30.5)	0.34 (8.7)	7/8 (22.23)
□□-FPP-4-□□□-R	1/4 BSPT	24.1 (0.95)	6.4 (0.25)	14.29 (9/16)
□□-FPP-6-□□□-R	3/8 BSPT	26.9 (1.06)	6.4 (0.25)	17.46 (11/16)
□□-FPP-8-□□□-R	1/2 BSPT	30.5 (1.20)	8.7 (0.34)	22.23 (7/8)

FPT Series

Basic Ordering No.	Tube O.D. (T)	Dimensions, in. (mm)		
		L	E	D
□□-FPT-4-□□□	1/4	0.81 (20.6)	0.17 (4.3)	3/8 (9.53)
□□-FPT-6-□□□	3/8	0.88 (22.4)	0.25 (6.4)	1/2 (12.70)
□□-FPT-8-□□□	1/2	1.12 (28.4)	0.25 (6.4)	5/8 (15.88)

Ordering Number Description

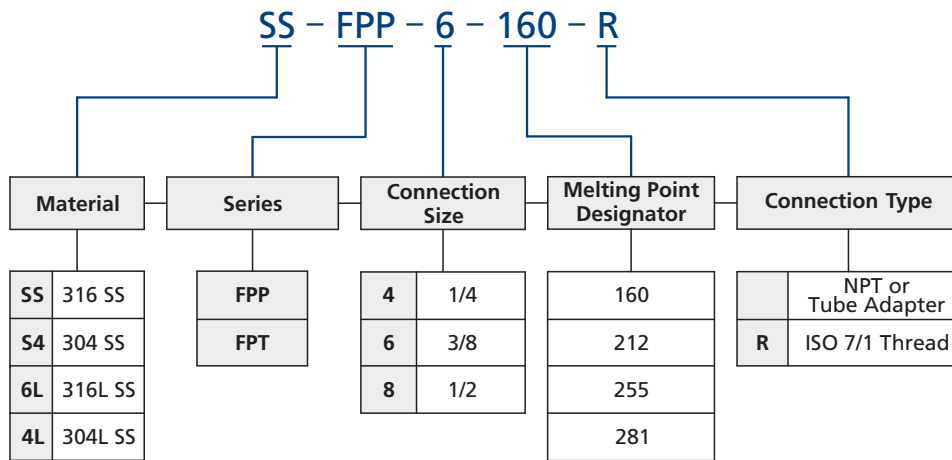

Note: "Ordering Number Description" is a reference to understand the combination rules of FITOK product part number. Not all combinations are available.

info@fitokgroup.com
www.fitokgroup.com

FK-IC-GF-07-EN-220622